

VPN1-06/M(R)

Size 04 (D02), 06 (D03) • Q_{max} 70 l/min (18.5 GPM) • p_{max} 320 bar (4600 PSI)

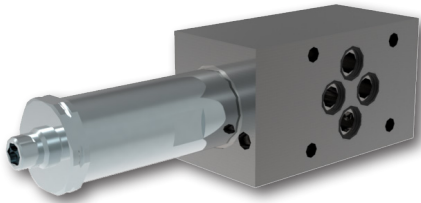

Technical Features

- › Pressure relief valve, spool type, pilot operated, with mounting interface acc. to ISO 4401, DIN 24340 (CETOP 02 and 03) or in-line design
- › Excellent stability throughout flow range with rapid response to dynamic pressure changes
- › Low hysteresis, accurate pressure control and low pressure drop
- › Wide pressure range up to 320 bar
- › High flow capacity
- › Hardened precision parts
- › Ideal for use as control valve where accuracy and repeatability is required
- › Adjustable by allen key or hand screw, optionally sealable (lockwire holes)
- › In the standard version, the valve housing is phosphated for basic surface corrosion protection and as preparation for painting. Steel parts are zinc-coated for 240 h salt spray protection acc. to ISO 9227
- › Enhanced surface protection for mobile sector available for the valve housing and steel parts (ISO 9227, 520 h salt spray)

Functional Symbols

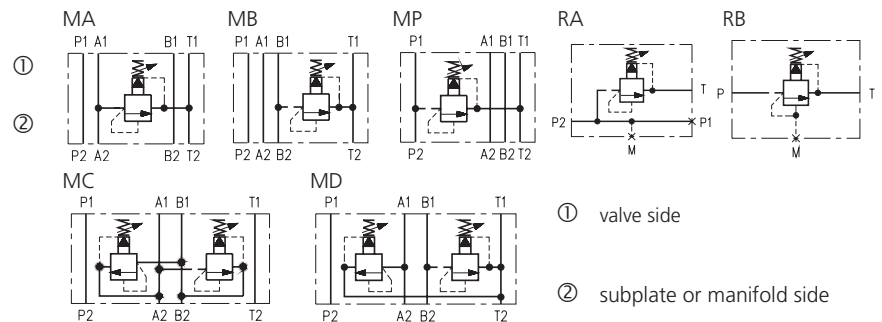

Notice: The orientation of the symbol on the name plate corresponds with the valve function.

ISO 4401-02-01-0-05

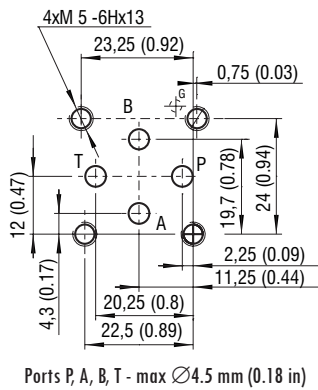

ISO 4401-03-02-0-05

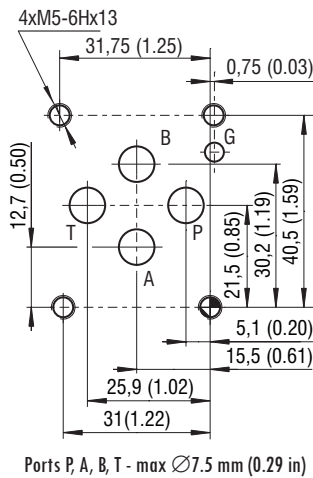

Technical Data

Valve size	04 (D02), 06 (D03)	
Max. flow	l/min (GPM)	70 (18.5)
Max. pressure (ports P, T)	bar (PSI)	320 (4640)
Fluid temperature range (NBR)	°C (°F)	-30...+100 (-22...+212)
Fluid temperature range (FPM)	°C (°F)	-20...+120 (-4...+248)
Weight - models MA (B, P) 04	kg (lbs)	0,82 (1.81)
- models MC (D) 04		1,32 (2.91)
- models MA (B, P) 06		1,2 (2.64)
- models MC (D) 06		1,5 (3.31)
- models RA1 (2), RB1 (2)		1,25 (2.76)
	Datasheet	Type
General information	GI_0060	Products operating conditions
Mounting interface	SMT_0019	Size 04 / 06
Spare parts	SP_8010	

Characteristics measured at $v = 32 \text{ mm}^2/\text{s}$ (156 SUS)

Relief pressure related to flow rate

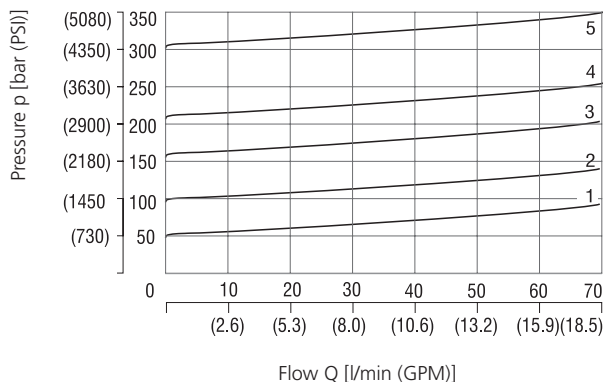

Minimum set and circulation pressure

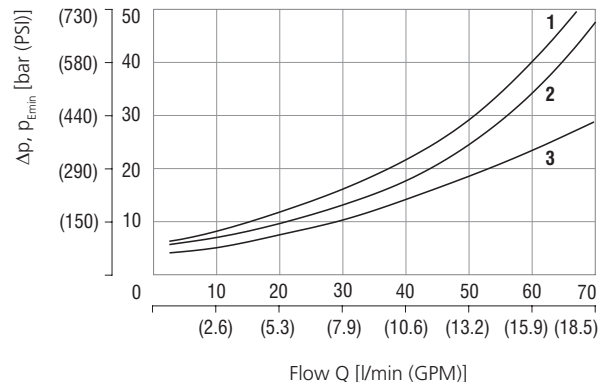

Dimensions in millimeters (inches)

Model MA

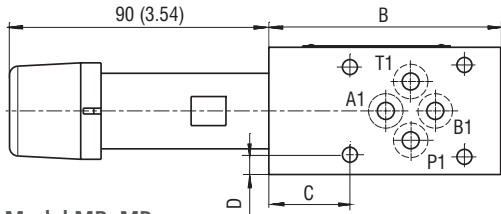

Model MC, MD

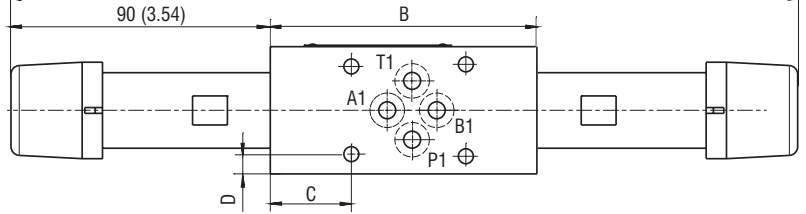

Model MB, MP

Size	04 (D02)	06 (D03)
MA, MB, MC, MD, MP	6.25 (0.25)	7 (0.28)
D	34.6 (1.36)	40 (1.57)
E	35 (1.38)	45 (1.77)

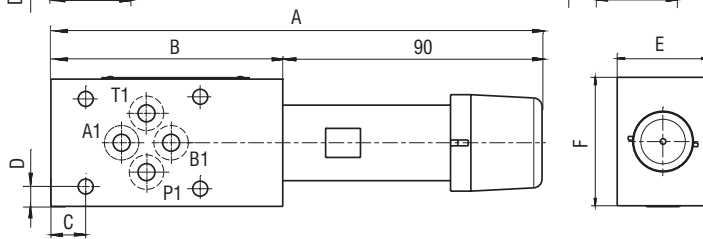

Version	Size	04 (D02)	06 (D03)
MA (B,P)	A	170 (6.70)	284 (11.18)
MC (D)	A	170 (6.70)	274 (10.79)
MA (B,P)	B	80 (3.15)	80 (3.15)
MC (D)	B	104 (4.09)	94 (3.70)
MA (C,D)	C	40 (1.57)	25,5 (1.0)
MB (P)	C	16 (0.63)	11,5 (0.45)

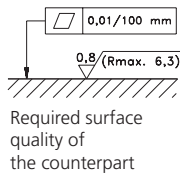

Model RA1, RA2

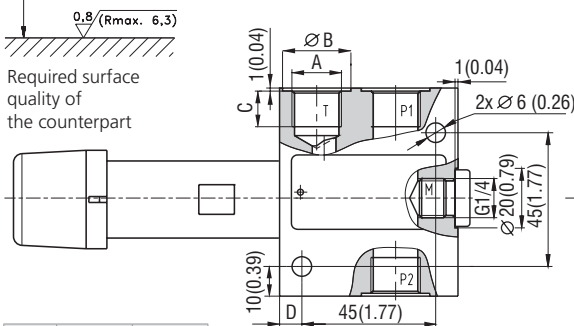

Size	RA1	RA2
E	60 (2.36)	70 (2.76)

Model RB1, RB2

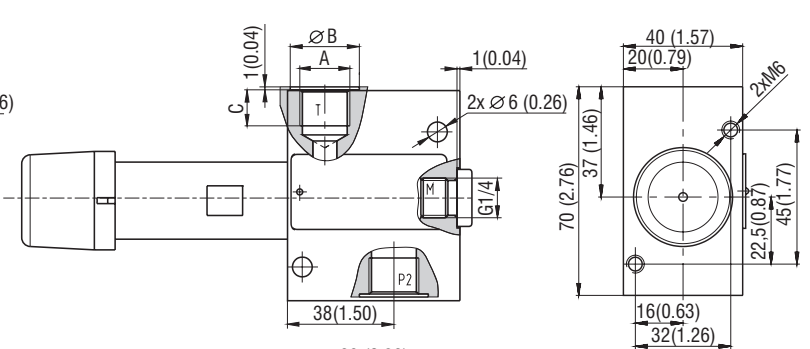

	RA1, RB1	RA2, RB2
A	G 3/8-A	G 1/2-A
B	Ø 23	Ø 28
C	12 (0.47)	14 (0.55)
D	7,5 (0.3)	18 (0.71)
F	39 (1.54)	46 (1.81)
G	12,5 (0.49)	16 (0.63)
H	117 (4.61)	127 (5.0)

Ordering Code

VPN1-06 / [] - [] - [] - [] - []

Pressure relief valve, spool type, pilot operated, modular

Model

- modular, valve from A to T **MA**
- modular, valve from B to T **MB**
- modular, valve from P to T **MP**
- modular, valve from A to B and B to A **MC**
- modular, valve from A to T and B to T **MD**
- in-line valve, three ports, thread G 3/8 (P1, P2, T) **RA1**
- in-line valve, three ports, thread G 1/2 (P1, P2, T) **RA2**
- in-line valve, two ports, thread G 3/8 (P, T) **RB1**
- in-line valve, two ports, thread G 1/2 (P, T) **RB2**

Modular plate size

- ISO 4401-02-01-0-05, DIN 24340 (CETOP 02), size 04 **04**
- ISO 4401-03-02-0-05, DIN 24340 (CETOP 03), size 06 **06**

Surface treatment
 No designation standard
A zinc-coated (ZnCr-3), ISO 9227 (240 h)
B zinc-coated (ZnNi, ISO 9227 (520 h)

Seals
 No designation NBR
V FPM (Viton)

Adjustment option*
S allen key (hex. 6), without protective cap
T allen key (hex. 6), with protective cap
RS hand screw, metal
RP hand screw, plastic
L allen key (hex. 6), with protective cap, sealable (lockwire holes)

Model with two pressure relief cartridges
S/RS A side, allen key (hex. 6), without protective cap
 B side, hand screw, metal

*for dimensions of adjustment options see datasheet No.5161

Pressure range
6 up to 63 bar (910 PSI)
10 up to 100 bar (1450 PSI)
16 up to 160 bar (2320 PSI)
21 up to 210 bar (3050 PSI)
32 up to 320 bar (4600 PSI)