

Solenoid directional valves type DHE

direct, spool type, high flow

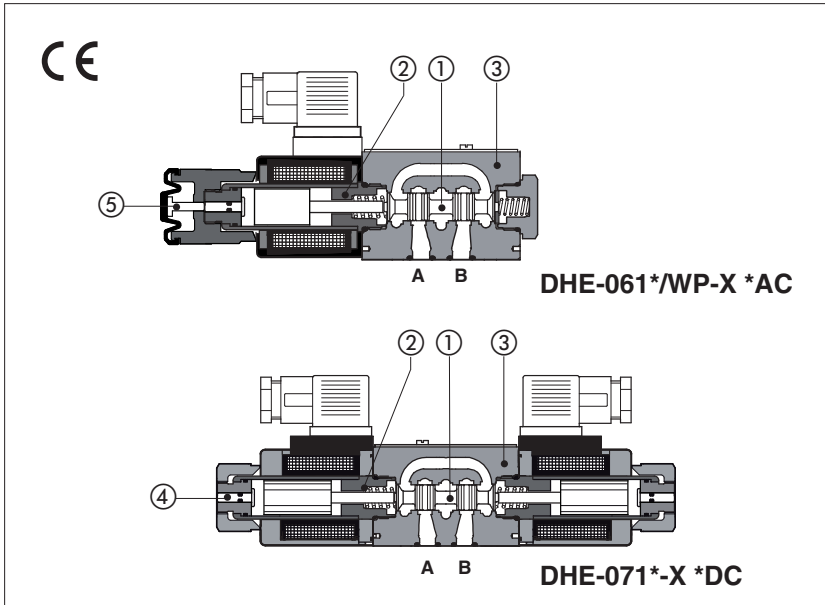

Spool type, two or three position direct operated valves with high performance threaded solenoids certified according the North American standard **cURus**.

Solenoids ② are made by:

- wet type screwed tube, different for AC and DC power supply, with integrated manual override pin ④
- interchangeable coils, specific for AC or DC power supply, easily replaceable without tools - see section ⑤ for available voltages

Standard coils protection **IP65** optional coils with IP67 AMP Junior Timer or lead wire connections.

Wide range of interchangeable spools ①, see section ②.

The valve body ③ is 3 chamber type made by shell-moulding casting with wide internal passages.

Mounting surface: **ISO 4401 size 06**

Max flow: **80 l/min**

Max pressure: **350 bar**

1 MODEL CODE

DHE - 0	61	1 / A	- X	24 DC	*	*
Directional control valves size 06					Series number	Seals material, see section ③: - = NBR PE = FKM BT = HNBR
Valve configuration, see section ②					Voltage code, see section ⑤	
<p>61 = single solenoid, center plus external position, spring centered</p> <p>63 = single solenoid, 2 external positions, spring offset</p> <p>67 = single solenoid, center plus external position, spring offset</p> <p>70 = double solenoid, 2 external positions, without spring</p> <p>71 = double solenoid, 3 positions, spring centered</p> <p>75 = double solenoid, 2 external positions, with detent</p>						
Spool type, see section ②.						
Options, see note 1 at section ④.						
						<p>00-AC = AC solenoids without coils</p> <p>00-DC = DC solenoids without coils</p> <p>X = without connector</p> <p>See section ④ for available connectors, to be ordered separately</p> <p>Coils with special connectors, see section ①①</p> <p>XJ = AMP Junior Timer connector</p> <p>XK = Deutsch connector</p> <p>XS = Lead Wire connection</p>

2 CONFIGURATIONS and SPOOLS (representation according to ISO 1219-1)

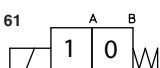
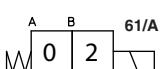
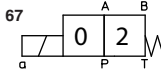
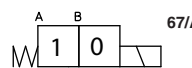
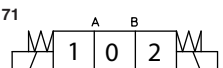
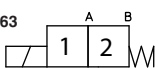
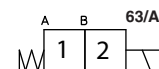
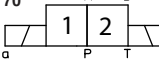
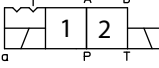
Configurations	Spools	Configurations	Spools
<p>61</p>  <p>61/A</p>  <p>67</p>  <p>67/A</p>  <p>71</p> 	<p>0 1 2 3 4 5 6 7 8 9 10 11 12 13 14 15 16 17 18 19 20 21 22 23 24 25 26 27 28 29 30 31 32 33 34 35 36 37 38 39 40 41 42 43 44 45 46 47 48 49 50 51 52 53 54 55 56 57 58 59 60 61 62 63 64 65 66 67 68 69 70 71 72 73 74 75 76 77 78 79 80 81 82 83 84 85 86 87 88 89 90 91 92 93 94 95 96 97 98 99 100 101 102 103 104 105 106 107 108 109 110 111 112 113 114 115 116 117 118 119 120 121 122 123 124 125 126 127 128 129 130 131 132 133 134 135 136 137 138 139 140 141 142 143 144 145 146 147 148 149 150 151 152 153 154 155 156 157 158 159 160 161 162 163 164 165 166 167 168 169 170 171 172 173 174 175 176 177 178 179 180 181 182 183 184 185 186 187 188 189 190 191 192 193 194 195 196 197 198 199 200 201 202 203 204 205 206 207 208 209 210 211 212 213 214 215 216 217 218 219 220 221 222 223 224 225 226 227 228 229 230 231 232 233 234 235 236 237 238 239 240 241 242 243 244 245 246 247 248 249 250 251 252 253 254 255 256 257 258 259 260 261 262 263 264 265 266 267 268 269 270 271 272 273 274 275 276 277 278 279 280 281 282 283 284 285 286 287 288 289 290 291 292 293 294 295 296 297 298 299 300 301 302 303 304 305 306 307 308 309 310 311 312 313 314 315 316 317 318 319 320 321 322 323 324 325 326 327 328 329 330 331 332 333 334 335 336 337 338 339 340 341 342 343 344 345 346 347 348 349 350 351 352 353 354 355 356 357 358 359 360 361 362 363 364 365 366 367 368 369 370 371 372 373 374 375 376 377 378 379 380 381 382 383 384 385 386 387 388 389 390 391 392 393 394 395 396 397 398 399 400 401 402 403 404 405 406 407 408 409 410 411 412 413 414 415 416 417 418 419 420 421 422 423 424 425 426 427 428 429 430 431 432 433 434 435 436 437 438 439 440 441 442 443 444 445 446 447 448 449 450 451 452 453 454 455 456 457 458 459 460 461 462 463 464 465 466 467 468 469 470 471 472 473 474 475 476 477 478 479 480 481 482 483 484 485 486 487 488 489 490 491 492 493 494 495 496 497 498 499 500 501 502 503 504 505 506 507 508 509 510 511 512 513 514 515 516 517 518 519 520 521 522 523 524 525 526 527 528 529 530 531 532 533 534 535 536 537 538 539 540 541 542 543 544 545 546 547 548 549 550 551 552 553 554 555 556 557 558 559 560 561 562 563 564 565 566 567 568 569 570 571 572 573 574 575 576 577 578 579 580 581 582 583 584 585 586 587 588 589 590 591 592 593 594 595 596 597 598 599 600 601 602 603 604 605 606 607 608 609 610 611 612 613 614 615 616 617 618 619 620 621 622 623 624 625 626 627 628 629 630 631 632 633 634 635 636 637 638 639 640 641 642 643 644 645 646 647 648 649 650 651 652 653 654 655 656 657 658 659 660 661 662 663 664 665 666 667 668 669 670 671 672 673 674 675 676 677 678 679 680 681 682 683 684 685 686 687 688 689 690 691 692 693 694 695 696 697 698 699 700 701 702 703 704 705 706 707 708 709 710 711 712 713 714 715 716 717 718 719 720 721 722 723 724 725 726 727 728 729 730 731 732 733 734 735 736 737 738 739 740 741 742 743 744 745 746 747 748 749 750 751 752 753 754 755 756 757 758 759 760 761 762 763 764 765 766 767 768 769 770 771 772 773 774 775 776 777 778 779 780 781 782 783 784 785 786 787 788 789 790 791 792 793 794 795 796 797 798 799 800 801 802 803 804 805 806 807 808 809 810 811 812 813 814 815 816 817 818 819 820 821 822 823 824 825 826 827 828 829 830 831 832 833 834 835 836 837 838 839 840 841 842 843 844 845 846 847 848 849 850 851 852 853 854 855 856 857 858 859 860 861 862 863 864 865 866 867 868 869 870 871 872 873 874 875 876 877 878 879 880 881 882 883 884 885 886 887 888 889 890 891 892 893 894 895 896 897 898 899 900 901 902 903 904 905 906 907 908 909 910 911 912 913 914 915 916 917 918 919 920 921 922 923 924 925 926 927 928 929 930 931 932 933 934 935 936 937 938 939 940 941 942 943 944 945 946 947 948 949 950 951 952 953 954 955 956 957 958 959 960 961 962 963 964 965 966 967 968 969 970 971 972 973 974 975 976 977 978 979 980 981 982 983 984 985 986 987 988 989 990 991 992 993 994 995 996 997 998 999 1000</p>	<p>63</p>  <p>63/A</p>  <p>70</p>  <p>75</p> 	<p>0/2 1/2 2/2 (2)</p>
	<p>(1): spool type 6/7 available only for configuration 61, not available for version /A</p>		<p>(2): not available for configuration 75</p>

Note: see also section ④, note 3, for special shaped spools

3 MAIN CHARACTERISTICS, SEALS AND HYDRAULIC FLUID - for other fluids not included in below table, consult our technical office

Assembly position / location	Any position		
Subplate surface finishing	Roughness index Ra 0,4 - flatness ratio 0,01/100 (ISO 1101)		
MTTFd values according to EN ISO 13849	150 years, for further details see technical table P007		
Ambient temperature	Standard = -30°C ÷ +70°C		/PE option = -20°C ÷ +70°C
Storage temperature	Standard = -30°C ÷ +80°C		/PE option = -20°C ÷ +80°C
Surface protection	Body: zinc coating with black passivation		Coil: zinc nickel coating (DC version) plastic encapsulation (AC version)
Corrosion resistance	Salt spray test (EN ISO 9227) > 200 h		
Compliance	CE to Low Voltage Directive 2014/35/EU RoHS Directive 2011/65/EU as last update by 2015/863/EU REACH Regulation (EC) n°1907/2006		
Seals, recommended fluid temperature	NBR seals (standard) = -20°C ÷ +80°C, with HFC hydraulic fluids = -20°C ÷ +50°C FKM seals (/PE option) = -20°C ÷ +80°C HNBR seals (/BT option) = -40°C ÷ +60°C, with HFC hydraulic fluids = -40°C ÷ +50°C		
Recommended viscosity	15÷100 mm²/s - max allowed range 2.8 ÷ 500 mm²/s		
Max fluid contamination level	ISO4406 class 20/18/15 NAS1638 class 9, see also filter section at www.atos.com or KTF catalog		
Hydraulic fluid	Suitable seals type	Classification	Ref. Standard
Mineral oils	NBR, FKM, HNBR	HL, HLP, HLPD, HVLP, HVLPD	DIN 51524
Flame resistant without water	FKM	HFDU, HFDR	ISO 12922
Flame resistant with water	NBR, HNBR	HFC	
Flow direction	As shown in the symbols of table 2		
Operating pressure	Ports P,A,B: 350 bar ; Port T 210 bar for DC version; 160 bar for AC version		
Rated flow	See diagrams Q/Δp at section 6		
Maximum flow	80 l/min , see operating limits at section 7		

3.1 Coils characteristics

Insulation class	H (180°C) for DC coils F (155°C) for AC coils Due to the occurring surface temperatures of the solenoid coils, the European standards EN ISO 13732-1 and EN ISO 4413 must be taken into account
Protection degree to DIN EN 60529	IP 65 (with connectors 666, 667, 669 correctly assembled)
Relative duty factor	100%
Supply voltage and frequency	See electric feature 5
Supply voltage tolerance	± 10%
Certification	cURus North American Standard

4 NOTES

1 Options

- A** = Solenoid mounted at side of port B (only for single solenoid valves). In standard versions, solenoid is mounted at side of port A.
- WP** = prolonged manual override protected by rubber cap.



The manual override operation can be possible only if the pressure at T port is lower than 50 bar - see section 12.

L1, L2, L3 = (only for DHE-DC) device for switching time control, installed in the valve solenoid, see section 9.
For spools 4 and 4/8 only device L3 is available.

FI, FV = with proximity or inductive position switch for monitoring spool position: see tab. E110.

MV, MO = auxiliary hand lever positioned vertically (MV) or horizontally (MO). For available configuration and dimensions see table E138.

2 Accessories

WPD/HE-DC = (only for DHE-DC) manual override with detent, to be ordered separately, see tab. K150

3 Special shaped spools

- spools type **0** and **3** are also available as **0/1** and **3/1** with restricted oil passages in central position, from user ports to tank.
- spools type **1, 4, 5** and **58** are also available as **1/1, 4/8, 5/1** and **58/1**. They are properly shaped to reduce water-hammer shocks during the swiching.
- spools type **1, 1/2, 3, 8** are available as **1P, 1/2P, 3P, 8P** to limit valve internal leakages.
- spool type **1/9** has closed center in rest position but it avoids the pressurization of A and B ports due to the internal leakages.
- Other types of spools can be supplied on request.

5 ELECTRIC FEATURES

External supply nominal voltage ± 10%	Voltage code	Type of connector	Power consumption (2)	Code of spare coil DHE		
12 DC	12 DC	666 or 667	30 W	COE-12DC		
14 DC	14 DC			COE-14DC		
24 DC	24 DC			COE-24DC		
28 DC	28 DC			COE-28DC		
48 DC	48 DC			COE-48DC		
110 DC	110 DC			COE-110DC		
125 DC	125 DC			COE-125DC		
220 DC	220 DC			COE-220DC		
24/50 AC	24/50/60 AC			58 VA (3)	COE-24/50/60AC (1)	
48/50 AC	48/50/60 AC				COE-48/50/60AC (1)	
110/50 AC	110/50/60 AC				COE-110/50/60AC (1)	
230/50 AC	230/50/60 AC				COE-230/50/60AC (1)	
115/50 AC	115/60 AC				80 VA (3)	COE-115/60AC
230/50 AC	230/60 AC					COE-230/60AC
110/50 AC - 120/60 AC	110 RC	30 W	COE-110RC			
230/50 AC - 230/60 AC	230 RC		COE-230RC			

(1) Coil can be supplied also with 60 Hz of voltage frequency: in this case the performances are reduced by 10 ÷ 15% and the power consumption is 52 VA.

(2) Average values based on tests performed at nominal hydraulic condition and ambient/coil temperature of 20°C.

(3) When solenoid is energized, the inrush current is approx 3 times the holding current.

6 Q/ΔP DIAGRAMS based on mineral oil ISO VG 46 at 50°C

Flow direction \ Spool type	Flow direction				
	P→A	P→B	A→T	B→T	P→T
0, 0/1	A	A	C	C	D
1, 1/1	D	C	C	C	
3, 3/1	D	D	A	A	
4, 4/8, 5, 5/1, 49, 58, 58/1, 94	F	F	G	C	E
1/2, 0/2	D	D	D	D	
6, 7, 16, 17	D	D	D	D	
8	A	A	E	E	
2	D	D			
2/2	F	F			
09, 19, 90, 91	E	E	D	D	
1/9, 39, 93	F	F	G	G	

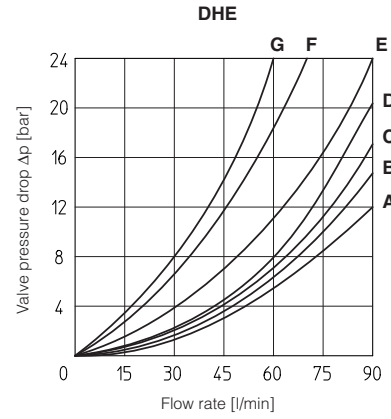

7 OPERATING LIMITS based on mineral oil ISO VG 46 at 50°C

The diagrams have been obtained with warm solenoids and power supply at lowest value ($V_{nom} - 10\%$). The curves refer to application with symmetrical flow through the valve (i.e. P→A and B→T). In case of asymmetric flow and if the valves have the devices for controlling the switching times the operating limits must be reduced.

Curve	Spool type	
	AC	DC
A	1, 1/2, 8	0, 0/1, 1, 1/2, 3, 8
B	0, 0/1, 0/2, 1/1, 1/9, 3	0/2, 1/1, 6, 7, 1/9, 19
C	3, 3/1, 6, 7	3/1, 4, 4/8, 5, 5/1, 16, 17, 19, 39, 49, 58, 58/1, 09, 90, 91, 93, 94
D	4, 4/8, 5, 5/1, 16, 17, 19, 39, 58, 58/1, 09, 90, 91, 93, 94	2, 2/2
E	2, 2/2	-

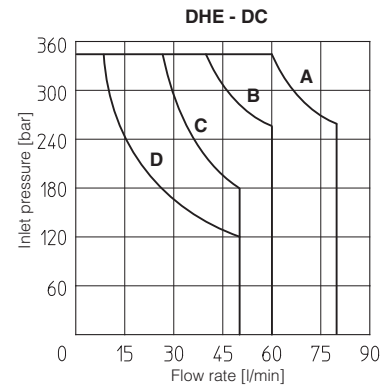
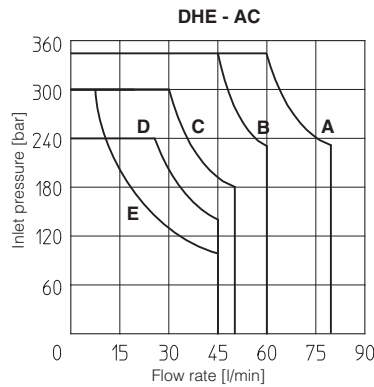

8 SWITCHING TIMES (average values in msec)

Test conditions: - 36 l/min; 150 bar
 - nominal voltage
 - 2 bar of counter pressure on port T
 - mineral oil: ISO VG 46 at 50°C

The elasticity of the hydraulic circuit and the variations of the hydraulic characteristics and temperature affect the response time.

Valve	Switch-on AC	Switch-off AC	Switch-on DC	Switch-off DC
DHE	10 - 25	20 - 40	30 - 50	15 - 25
DHE-*/L1	—	—	60	60
DHE-*/L2	—	—	80	80
DHE-*/L3	—	—	150	150

9 DEVICES FOR THE SWITCHING TIME CONTROL

These devices are used to control the valve's switching time (only for DC version) and therefore reduce the hammering shocks in the hydraulic circuit.

Options L1, L2, L3 control the switching time in both moving directions of the valve spool by means of calibrated restrictors installed in the solenoid anchor.

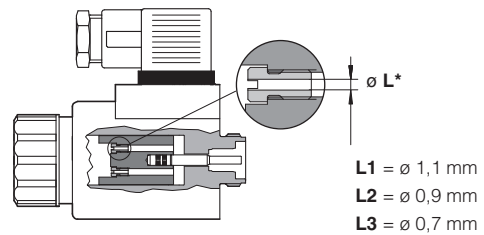

10 SWITCHING FREQUENCY

Valve	AC (cycles/h)	DC (cycles/h)
DHE + 666 / 667	7200	15000

11 COIL WITH SPECIAL CONNECTORS only for voltage supply 12, 14, 24, 28 Vdc

AMP Junior timer connector	Deutsch connector DT-04-2P	Lead Wire connection
<p>Options -XJ Coil type COEJ AMP Junior Timer connector Protection degree IP67</p>	<p>Options -XK Coil type COEK Deutsch connector DT-04-2P male Protection degree IP67</p>	<p>Options -XS Coil type COES Lead Wire connection Cable length = 180 mm</p>

Note: for the electric characteristics refer to standard coils features - see section 5

12 DIMENSIONS [mm]

ISO 4401: 2005

Mounting surface: 4401-03-02-0-05

Fastening bolts: 4 socket head screws:

M5x30 class 12.9

Tightening torque = 8 Nm

Seals: 4 OR 108

Ports P,A,B,T: $\varnothing = 7.5$ mm (max)

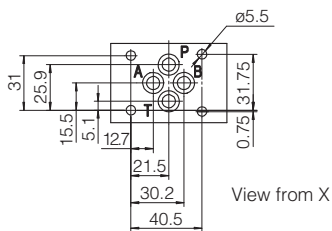

P = PRESSURE PORT
A, B = USE PORT
T = TANK PORT

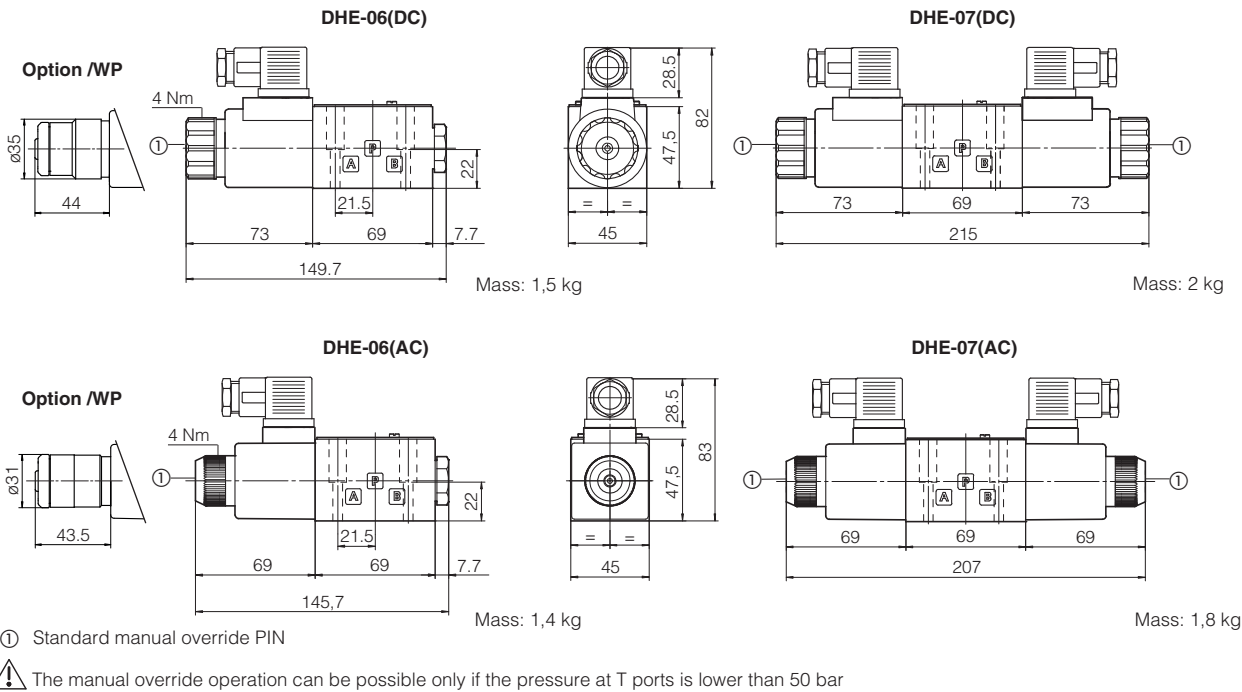

Overall dimensions refer to valves with connector 666

13 PLUG-IN RESTRICTOR (to be ordered separately)

The use of plug-in restrictors in valve's ports P or A or B may be necessary in case of particular conditions as long flexible hoses or the presence of accumulators which could cause at the valve switching instantaneous high flow peaks over the max valve's operating limits.

PLUG-H	-	**	A
<p>08, 10, 12, 15 calibrated orifice diameter in tenths of mm Example PLUG-H-12 = orifice diameter 1,2 mm Other orifice dimensions are available on request</p>			
<p>Short calibrated orifice</p>			

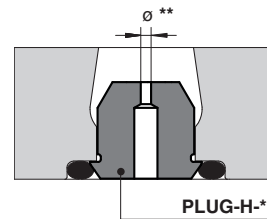

14 ELECTRIC CONNECTORS ACCORDING TO DIN 43650 (to be ordered separately)

666 = standard connector IP-65, suitable for direct connection to electric supply source

667 = as 666, but with built-in signal led. Available for power supply voltage 24 AC or DC, 110 AC or DC, 220 AC or DC

669 = with built-in rectifier bridge for supplying DC coils by alternate current (AC 110V and 230V - I_{max} 1A)

15 MOUNTING SUBPLATES

Model	Ports location	GAS Ports A-B-P-T	Ø Counterbore [mm] A-B-P-T	Mass [kg]
BA-202	Ports A, B, P, T underneath;	3/8"	-	1,2
BA-204	Ports P, T underneath; ports A, B on lateral side	3/8"	25,5	1,8
BA-302	Ports A, B, P, T underneath	1/2"	30	1,8

The subplates are supplied with 4 fastening bolts M5x50. Also available are multi-station subplates and modular subplates. For further details see table K280.