

ISO cartridge valves type LIM*, LIRA, LIC*

Pressure controls: relief, reducing, compensator - **Pmax 420 bar**

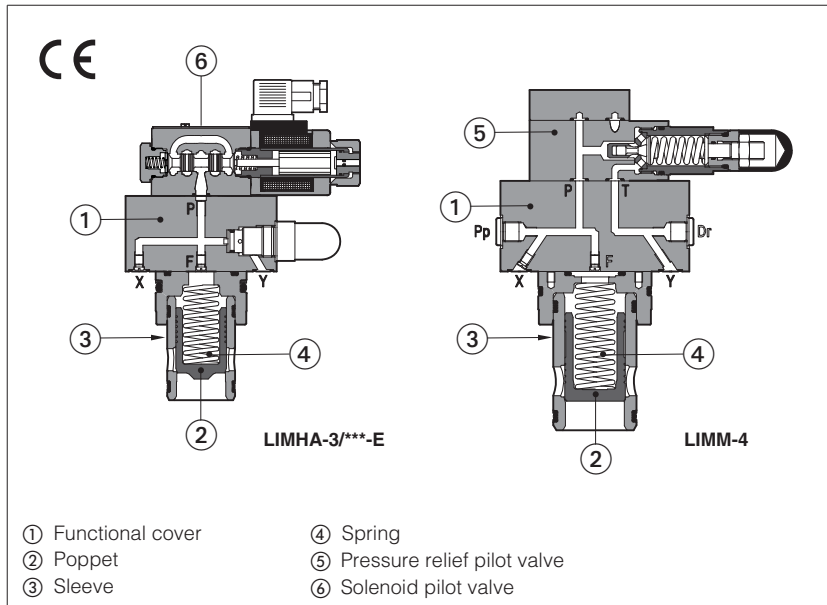

Pressure control valves in ISO cartridge design specific for relief, reducing or compensator functions

They are made by a functional cover ① and a 2-way **SC LI** slip-in cartridge.

Depending to the type of control, the cover is equipped with a pilot relief valve ⑤ for the max pressure regulation and a solenoid valve ⑥ for venting.

The SC LI slip-in cartridge is available with different poppet shape to optimize the pressure control, see section ④

It is made by a poppet ② sliding into a sleeve ③ and kept in normally closed position by the spring ④ available with different cracking pressure values.

Size: **16 to 80** ISO 7368
 Max flow up to **4900 l/min** at $\Delta p = 5$ bar
 Max pressure: up to **420 bar**

1 MODEL CODE OF FUNCTIONAL COVERS - for model code of slip-in cartridge, see section ⑤

LI	MHA	-	1	/	210	/	V	-	E	X	24DC	**	/	*	F**	
Cover according to ISO 7368																Optional different setting of calibrated plugs in the pilot channels, see section ③, ④
<p>Function:</p> <p>MM = pressure relief control with manual setting;</p> <p>MHA = pressure relief control with solenoid valve for venting. Unloading when solenoid is deenergized;</p> <p>MHC = pressure relief control with solenoid valve for venting. Unloading when solenoid is energized;</p> <p>RA = pressure reducing control with manual setting. Open in resting position;</p> <p>C = pressure compensator to be coupled with flow control valves;</p> <p>CM = pressure compensator with mechanical max pressure regulation to be coupled with flow control valves.</p>																
<p>Size: 1 = 16; 2 = 25; 3 = 32; 4 = 40; 5 = 50; 6 = 63; 8 = 80</p> <p>LIRA is available only in size 16, 25, 32, 40</p>																
<p>Pressure range:</p> <p>50 = 6 ÷ 50 bar;</p> <p>100 = 8 ÷ 100 bar; 350 = 15 ÷ 350 bar;</p> <p>210 = 10 ÷ 210 bar; 420 = 25 ÷ 420 bar (1)</p>																
<p>Seals material:</p> <p>- = NBR</p> <p>PE = FKM</p> <p>BT = HNBR (2)</p>																
<p>Series number</p>																
<p>Voltage code only for LIMHA and LIMHC, see section ②</p>																
<p>Only for LIMHA and LIMHC</p> <p>X = without connector</p> <p>00-AC = AC solenoid valve without coils</p> <p>00-DC = DC solenoid valve without coils</p> <p>See tech. table K800 for available connectors, to be ordered separately</p>																
<p>Pilot solenoid valve only for LIMHA and LIMHC:</p> <p>E = DHE, Pmax 350 bar</p> <p>EP = DHEP, Pmax 420 bar (1)</p> <p>L = DHL, Pmax 350 bar</p>																
<p>Options: see section ③</p>																

(1) Pressure range 420 bar not available for LIMH*-E and LIMH*-L; LIMH*-EP is available only for pressure range 420 bar

(2) Not available for LIMH*-L

2 HYDRAULIC SYMBOLS

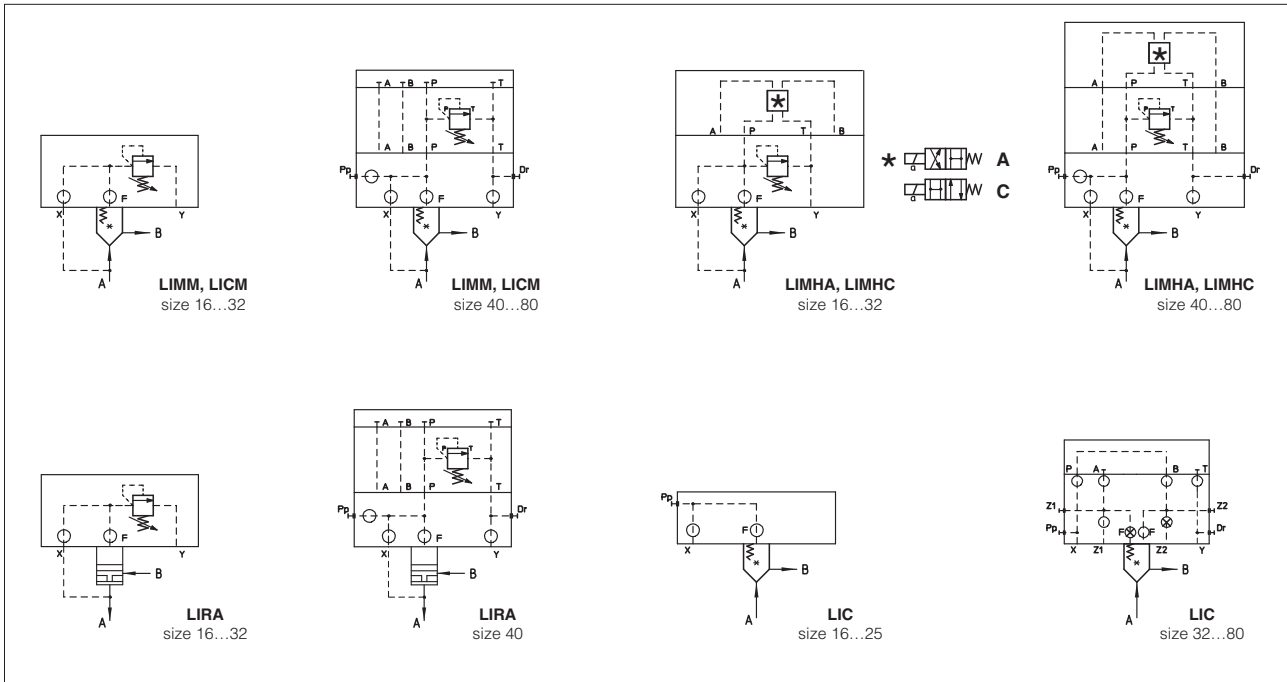

3 OPTIONS

Only for LIMM (size 16...32):

/P = predisposed for ISO 4401 size 06 mounting surface

Handwheel for pressure control, only for LIMM, LIMH*, LIRA, LICM (see tech. table K150):

/V = regulating handwheel (available for all the sizes)

/WF = regulating knob (available only for sizes 40...80)

/VS = manual override with safety locking (available only for sizes 40...80)

/WPA = prolonged manual override protected by rubber cap for pilot solenoid valve

For all the models:

******* = calibrated plugs different from standard one. The restrictors configuration (if different from the standard) must be indicated at the end of the model code:

LIMHA

- 1 /

210 -

EX

24DC

F

06

Channel where the orifice has to be provided:

X = channel X

F = channel F

Size of the throttling hole in tenths of millimeters:

05 = 0,5 mm **10** = 1 mm

06 = 0,6 mm **12** = 1,2 mm

08 = 0,8 mm **15** = 1,5 mm

000 = without restrictors

4 STANDARD ORIFICES CONFIGURATION

Cover \ Port	LIM*-1		LIRA-1		LICM-1		LIC-1		LIM*-2		LIRA-2		LICM-2		LIC-2		LIM*-3		LIRA-3		LICM-3		LIC-3		LIM*-4		LIRA-4		LICM-4		LIC-4		LIM*-5		LICM-5		LIC-5		LIM*-6		LICM-6		LIC-6		LIM*-8		LICM-8		LIC-8	
	X	F	X	F	X	F	X	F	X	F	X	F	X	F	X	F	X	F	X	F	X	F	X	F	X	F	X	F	X	F	X	F	X	F	X	F	X	F	X	F	X	F								
X	M4 10A	M4 08A	M4 08A	-	M4 10A	M4 08A	M4 08A	-	M6 10A	M6 08A	M6 12A	M6 10A	M6 10A	M6 12A	M6 10A	M6 10A	M6 10A	M6 10A	M6 10A	M6 10A	M6 10A	M6 10A	M6 10A	M6 10A	M6 10A	M6 10A	M6 10A	M6 10A	M6 10A	M6 10A	M6 10A	M6 10A	M6 10A	M6 10A	M6 10A	M6 10A	M6 10A	M6 10A	M6 10A	M6 10A	M6 10A	M6 10A	M6 10A	M6 10A	M6 10A	M6 10A	M6 10A	M6 10A	M6 10A	M6 10A
F	M4 12F	M4 12A	M4 05F	M4 05F	M4 12F	M4 12A	M4 05F	M4 05F	M6 12F	M6 12A	M6 12F	M6 05F	M6 12F	M6 08A	M6 12F	M6 12F	M6 12F	M6 12F	M6 12F	M6 12F	M6 12F	M6 12F	M6 12F	M6 12F	M6 12F	M6 12F	M6 12F	M6 12F	M6 12F	M6 12F	M6 12F	M6 12F	M6 12F	M6 12F	M6 12F	M6 12F	M6 12F	M6 12F	M6 12F	M6 12F	M6 12F	M6 12F	M6 12F	M6 12F	M6 12F	M6 12F	M6 12F	M6 12F	M6 12F	M6 12F

M4 ÷ M8 = screw size; **10A ÷ 12F** = calibrated orifice diameter in tenths of mm; **A** = short calibrated hole, **F** = long calibrated hole

5 MODEL CODE OF SLIP-IN CARTRIDGES

SC LI	-	16	31	2	**	/*
Cartridge according to ISO 7368						
Size, the same of relevant cover: 16 = 16; 32 = 32; 50 = 50; 80 = 80 25 = 25; 40 = 40; 63 = 63;						

Type of poppet

31 = (sizes 16...80) = for LIMM, LIMH*, LIC, LICM
34 = (size 16) = for LIMM, LIMH*
35 = (sizes 16...50) = for LIMM, LIMH*
36 = (sizes 16...80) = for LIC, LICM
37 = (sizes 16...40) = for LIRA

Series number

Seals material:
 - = NBR
PE = FKM
BT = HNBR

Spring cracking pressure:

1 = 0,3 bar for poppet 35;
2 = 1,2 bar for poppet 31, 34, 35;
3 = 3 bar for poppet 31, 34, 35;
4 = 4 bar for poppet 37;
6 = 6 bar for poppet 31, 34, 35, 36;
7 = 7 bar for poppet 37;

6 TYPE OF POPPET

Type of poppet	31	34	35	36	37
Operating pressure	420 bar				
Nominal flow Size 16	180	180	180	180	140
at Δp 5bar	25 370	-	370	370	250
(l/min)	32 630	-	630	630	500
see diagrams Q/ Δp	40 1100	-	1100	1100	750
at section ⑧	50 1900	-	1900	1900	-
	63 3100	-	-	3100	-
	80 4900	-	-	4900	-
Functional sketch (Hydraulic symbol)					
Typical section					
Area ratio A: Ap	1:1	1:1	1:1,1	1:1	1:1

7 MAIN CHARACTERISTICS SEALS AND HYDRAULIC FLUIDS

Assembly position / location	Any position		
Subplate surface finishing	Roughness index Ra 0,4 - flatness ratio 0,01/100 (ISO 1101)		
MTTFd values according to EN ISO 13849	150 years, for further details see technical table P007		
Ambient temperature	Standard execution = -30°C ÷ +70°C /PE option = -20°C ÷ +70°C /BT option = -40°C ÷ +70°C		
Compliance	CE to Low Voltage Directive 2014/35/EU RoHS Directive 2011/65/EU as last update by 2015/863/EU REACH Regulation (EC) n°1907/2006		
Seals, recommended fluid temperature	NBR seals (standard) = -20°C ÷ +80°C, with HFC hydraulic fluids = -20°C ÷ +50°C FKM seals (/PE option) = -20°C ÷ +80°C HNBR seals (/BT option) = -40°C ÷ +60°C, with HFC hydraulic fluids = -40°C ÷ +50°C		
Recommended viscosity	15 ÷ 100 mm²/s - max allowed range 2.8 ÷ 500 mm²/s		
Fluid contamination class	ISO 4406 class 21/19/16 NAS 1638 class 10, in line filters of 25 µm (β ₂₅ ≥ 75 recommended)		
Hydraulic fluid	Suitable seals type	Classification	Ref. Standard
Mineral oils	NBR, FKM, HNBR	HL, HLP, HLPD, HVLP, HVLPD	DIN 51524
Flame resistant without water	FKM	HFDR, HFDR	ISO 12922
Flame resistant with water	NBR, HNBR	HFC	
Flow direction	As shown in the symbols of table ②		
Functional cover operating pressure	all models except LIMH* LIMH*-E, LIMH*-L LIMH*-EP	Ports A, B, X: 420 bar; Ports A, B, X: 350 bar; Port T 210 bar for DC version; 160 bar for AC version Ports A, B, X: 420 bar; Port T 210 bar for DC version; 160 bar for AC version	

7.1 Coils characteristics

Insulation class	H (180°C) for DC coils F (155°C) for AC coils Due to the occurring surface temperatures of the solenoid coils, the European standards EN ISO 13732-1 and EN ISO 4413 must be taken into account
Protection degree to DIN EN 60529	IP 65 (with connectors 666, 667, 669 correctly assembled)
Relative duty factor	100%
Supply voltage and frequency	See electric feature ⑨
Supply voltage tolerance	± 10%
Certification	cURus North American Standard (not for -L)

8 FLOW / Δp DIAGRAMS based on mineral oil ISO VG 46 at 50 °C

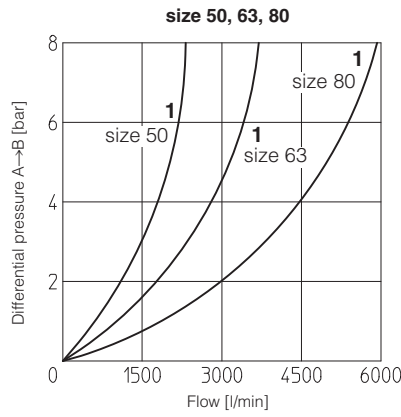
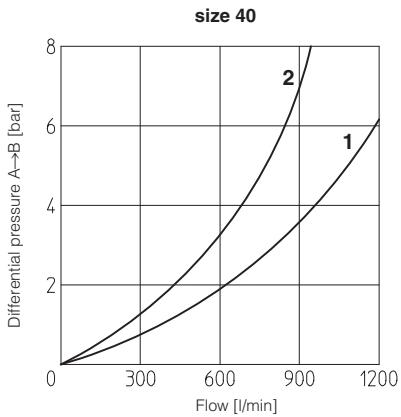
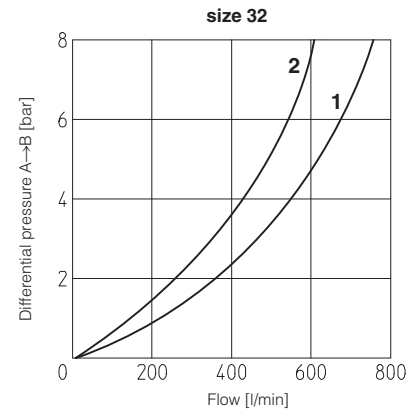
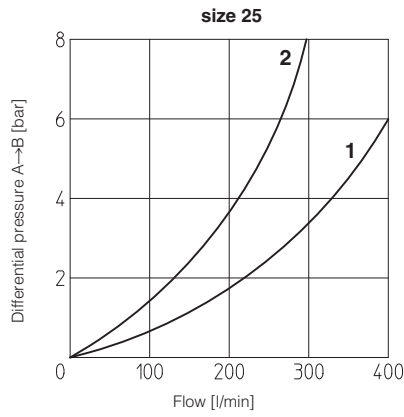
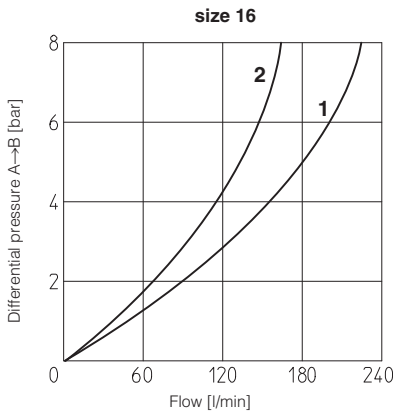

1 = poppet type 31, 34, 35, 36
2 = poppet type 37

Note:
 poppet type 34 only for size 16
 poppet type 37 for size 16 to 40

9 ELECTRIC FEATURES

Solenoid valve type	External supply nominal voltage $\pm 10\%$ (1)		Voltage code	Type of connector	Power consumption (3)	Code of spare coil DHE, DHEP	Code of spare coil DHL
	DC	AC					
DHE DHEP DHL	DC	12 DC 24 DC 110 DC 220 DC	12 DC 24 DC 110 DC 220 DC	666 or 667	29 W (DHL) 30 W (DHE, DHEP)	COE-12DC COE-24DC COE-110DC COE-220DC	COL-12DC COL-24DC COL-110DC COL-220DC
	AC	110/50 AC (2) 115/60 AC 120/60 AC 230/50 AC (2) 230/60 AC	110/50 AC 115/60 AC 120/60 AC 230/50 AC 230/60 AC	666 or 667	58 VA (4)	COE-110/50/60AC COE-115/60AC COE-230/50/60AC COE-230/60AC	COL-110/50/60AC COL-115/60AC COL-230/50/60AC COL-230/60AC

(1) For other supply voltages available on request see technical tables E015, E030, E018.

(2) Coil can be supplied also with 60 Hz of voltage frequency: in this case the performances are reduced by 10÷15% and the power consumption is 55 VA for DHL and 52VA for DHE and DHEP

(3) Average values based on tests performed at nominal hydraulic condition and ambient/coil temperature of 20°C.

(4) When solenoid is energized, the inrush current is approx 3 times the holding current. Inrush current values correspond to a power consumption of about 150 VA.

10 COVER DIMENSIONS [mm] - for mounting interface and cavity dimensions see tech. table P006

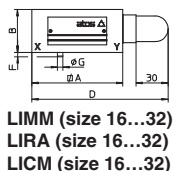

LIMM (size 16...32)
LIRA (size 16...32)
LICM (size 16...32)

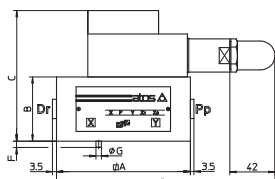

LIMM (size 40...80)
LIRA (size 40)
LICM (size 40...80)

Covers	A	B	C	D	F	G	Port Pp-Dr	Seals	Fastening bolts (2)	Tightening torque [Nm]	Mass [Kg]
LIMM-1 LIRA-1 LICM-1	65	40	-	107,5	4	3	-	2 OR 108	Nr. 4 M8x45	35	1,7
LIMM-2 LIRA-2 LICM-2	85	40	-	127,5	6	5	-	2 OR 108	Nr. 4 M12x45	125	2,2
LIMM-3 LIRA-3 LICM-3	100	50	-	142,5	6	5	-	2 OR 2043	Nr. 4 M16x55	300	3,5
LIMM-4 LIRA-4 LICM-4	125	60	122	195	6	5	G 1/4	2 OR 3043	Nr. 4 M20x70	600	8,9
LIMM-5 LICM-5	140	70	132	202,5	4	6	G 1/4	2 OR 3043	Nr. 4 M20x80	600	12,4
LIMM-6 LICM-6	180	80	142	222,5	4	6	G 3/8	2 OR 3050	Nr. 4 M30x90	2100	21,6
LIMM-8 LICM-8	Ø250	80	172	257,5	6	8	G 3/8	2 OR 4075	Nr. 8 M24x90	1000	30,5

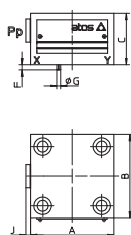

LIC (size 16 ÷ 25)

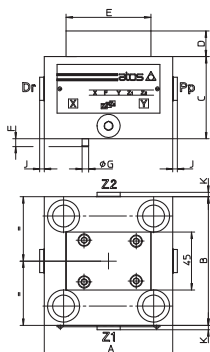

LIC (size 32...80)

Covers	A	B	C	D	E	F	G	K	J	Port Pp-Dr	Port Z1-Z2	Seals	Fastening bolts (2)	Tightening torque [Nm]	Mass [Kg]
LIC-1	65	65	40	-	4	3	-	3,5	3,5	G 1/4	-	2 OR 108	Nr. 4 M8x45	35	1,4
LIC-2	85	85	40	-	6	5	-	3,5	3,5	G 1/4	-	2 OR 108	Nr. 4 M12x45	125	1,8
LIC-3	100	100	50	20	66	6	5	-	3,5	G 1/4	-	4 OR 2043	Nr. 4 M16x55	300	2,3
LIC-4	125	125	60	20	66	6	5	-	3,5	G 1/4	-	4 OR 3043	Nr. 4 M20x70	600	6,2
LIC-5	140	140	70	20	66	4	6	3,5	3,5	G 1/4	G 1/4	4 OR 3043	Nr. 4 M20x80	600	9,3
LIC-6	180	180	80	20	66	4	6	3,5	3,5	G 3/8	G 3/8	4 OR 3050	Nr. 4 M30x90	2100	17,1
LIC-8	Ø 250	-	80	30	73	6	8	-	3,5	G 3/8	-	4 OR 4075	Nr. 8 M24x90	1000	27

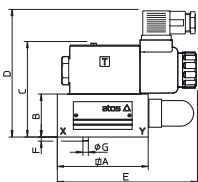

LIMH* (size 16...32)

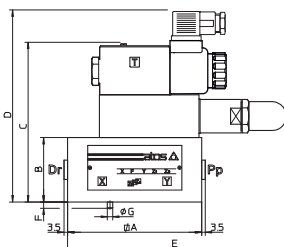

LIMH* (size 40...80)

Covers	A	B	C max	D max	E	F	G	Port Pp-Dr	Seals	Fastening bolts (2)	Tightening torque [Nm]	Mass [Kg]
LIMHA-1 LIMHC-1	65 (1)	40	87,5	123,5	124,5	4	3	-	2 OR 108	Nr. 4 M8x45	35	3
LIMHA-2 LIMHC-2	85	40	87,5	123,5	134,5	6	5	-	2 OR 108	Nr. 4 M12x45	125	3,3
LIMHA-3 LIMHC-3	100	50	130,5	153,5	142,5	6	5	-	2 OR 2043	Nr. 4 M16x55	300	5
LIMHA-4 LIMHC-4	125	60	150,5	183,5	195	6	5	G 1/4	2 OR 3043	Nr. 4 M20x70	600	9,2
LIMHA-5 LIMHC-5	140	70	160,5	193,5	202,5	4	6	G 1/4	2 OR 3043	Nr. 4 M20x80	600	13,2
LIMHA-6 LIMHC-6	180	80	170,5	203,5	222,5	4	6	G 3/8	2 OR 3050	Nr. 4 M30x90	2100	22,5
LIMHA-8 LIMHC-8	Ø 250	80	200,5	233,5	257,5	6	8	G 3/8	2 OR 4075	Nr. 8 M24x90	1000	31,3

(1) Cover is not squared: 65x80

(2) Hexagon socket head screw according to DIN 912 class 12.9