

Pilot operated check valve

Type SV / SL...L4X

Sizes 10 to 32
Up to 315bar
Up to 550 L/min

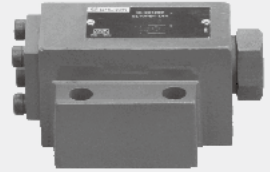

Contents

Function and configurations	02
Symbols	02
Ordering code	03
Technical data	03
Characteristic curves	04
Unit dimensions	05-07
· sub-plate mounting valve	05
· threaded connection valve	06-07
Ordering code for threaded connection valve type SV/SL series 30	07

Features

- For sub-plate mounting,
porting pattern conforms to DIN 24 340 Form D,
ISO 5781
- For threaded connection
- With or without drain port
- With or without unloading function
- 4 cracking pressures

Function and configuration

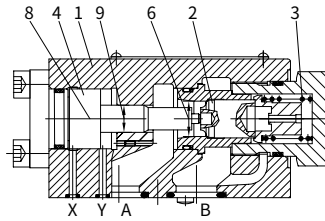
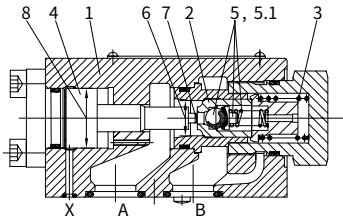

- 6 Area A1
- 7 Area A2
- 8 Area A3
- 9 Area A4

SV and SL valves are hydraulic pilot operated check valves in poppet type design which may be opened to permit reverse flow.

These valves are used for the isolation of operating circuits under pressure, to prevent a load from falling or creeping movements of hydraulically locked-in actuators.

Basically these valves consist of housing (1), poppet (2), compression spring (3), control spool (4) as well as a optional pre-opening ball poppet valve (5).

Type SV (without drain port)

The valve permits free-flow from A to B. In the reverse direction, the poppet (2) is held firmly on to its seat in addition to the spring force by the system pressure.

By applying pressure at control port X the control piston (4) is moved to the right. This lifts the poppet (2) from the seat, then fluid flows from B to A.

In order to ensure the valve opens due to the

pressure applied to the control piston (4) a certain minimum pilot pressure is necessary.

Type SV...A...and SL...A... (with pre-opening)

This valve has a additional decompression feature. When pressure is applied at control port X the control piston (4) is pushed to the right. The ball poppet (5.1) leaves first then the poppet (2) leaves from the seat. Now the valve may also have a flow from B to A.

Because of the pre-opening there is a dampened decompression of the fluid under pressure to avoid possible pressure shocks.

Type SL... (with drain port)

The function of this valve correspond to the valve SV .

The difference is the additional leakage port Y. The annular area of the control piston (4) is separated from port A. The pressure at port A only effects area A4 (9) of the control piston (4).

Symbols



Symbols type SV

Type SV..PA.-L4X/...
(without drain port, with pre-opening)



Symbols type SL

Type SL..PB.-L4X/...
(with drain port, without pre-opening)

Ordering code

	S						- L4X/		*
--	---	--	--	--	--	--	--------	--	---

No leakage port = V
With leakage port = L

Type	SV		SL	
	G	P	G	P
Connected port				
Size	Code			
Size 10	=10	=10	=10	=10
Size 16	=15	-	=15	-
Size 20	=20	=20	=20	=20
Size 25	=25	-	=25	-
Size 32	=30	=30	=30	=30

Sub-plate mounting = P
Threaded connection = G

With pre-opening (standard version) = A
No pre-opening = B

Further details in clear text

No code = NBR seals
V = FKM seals

For threaded connection

No code = Inch
2 = Metric

L4X = Series L40 to L49
(L40 to L49: unchanged installation and connection dimensions)

1= Cracking pressure: Size 10 = 1.5bar
Size16 and 20 = 2.5bar
Size25 and 32 = 2.5bar

2= Cracking pressure: Size10 = 3bar
Size16 and 20 = 5bar
Size25 and 32 = 5bar

3= Cracking pressure: Size10 = 6bar
Size16 and 20 = 7.5bar
Size25 and 32 = 8bar

4= Cracking pressure: = 10bar

Technical data

Nominal size		10	16	20	25	32	
Weight	Sub plate mounting	kg	2.1		4.7	7.8	
	Threaded connection	kg	2.5	5.7	5.7	10	10
Installation position		Optional					
Flow direction		From A to B free, from B to A through opening					
Operating pressure		bar	To 315				
Port pilot pressure		bar	5 to 315				
Control capacity -Port X		cm ³	2.5	10.8	10.8	19.27	19.27
-Port Y (only type SL)		cm ³	2	9.6	9.6	17.5	17.5
Control area-area A1		cm ²	1.33	3.46	3.46	5.72	5.72
-area A2		cm ²	0.33	0.7	0.7	1.33	1.33
-area A3		cm ²	3.8	10.17	10.17	16.61	16.61
-area A4		cm ²	0.79	1.13	1.13	1.54	1.54
Viscosity range		mm ² /s	10 to 800				
Fluid temperature range		°C	-30 to +80 (NBR seal) -20 to +80 (FKM seal)				
Fluid		Mineral oil suitable for NBR and FKM seal Phosphate ester for FKM seal					
Degree of contamination		Maximum permissible degree of fluid contamination: Class 9. NAS 1638 or 20/18/15, ISO4406					

Characteristic curves

(Measured at $\vartheta_{oil} = 40^{\circ}\text{C} \pm 5^{\circ}\text{C}$, using HLP46)

ΔP -Q curves – sub plate mounting

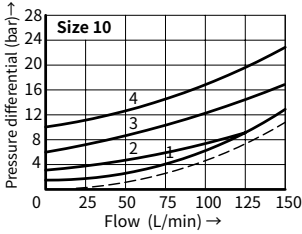

ΔP -Q curves – threaded connection

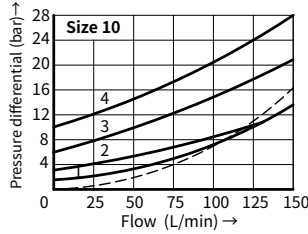

A to B Cracking pressure

- 1 1.5bar
- 2 3bar
- 3 6bar
- 4 10bar
- B to A

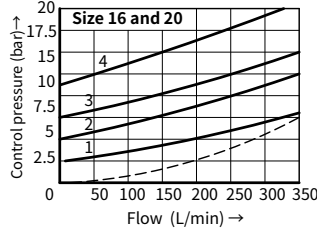
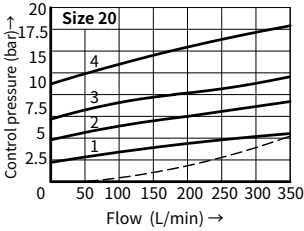

A to B Cracking pressure

- 1 2.5 bar
- 2 5bar
- 3 7.5bar
- 4 10bar
- B to A

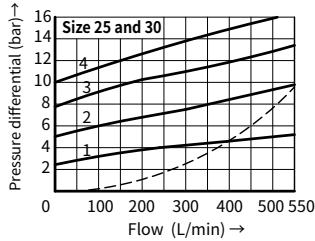
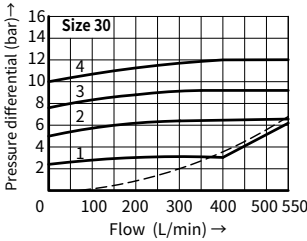

A to B Cracking pressure

- 1 2.5bar
- 2 5bar
- 3 7.5bar
- 4 10bar
- B to A

Control pressure-load pressure curves

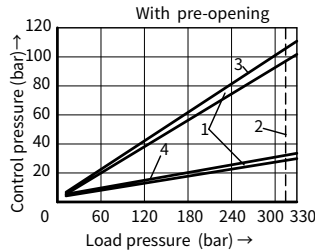
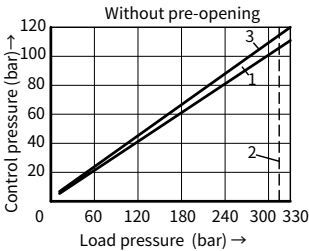

- 1 Tolerance range
- 2 Limit value
- 3 Poppet
- 4 Pre-opening ball poppet valve

Unit dimensions

(Dimensions in mm)

• sub-plate mounting valve

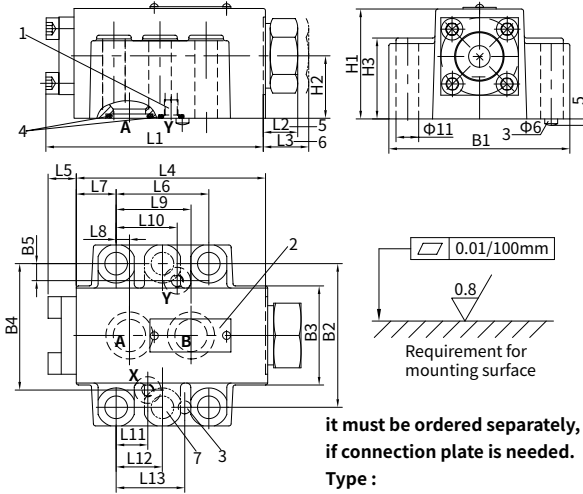

- 1 Port Y with valve type "SL" (with valve type "SV" this port is closed)
- 2 Name plate
- 3 Locating pin
- 4 O-rings

Size 10

- Ports A and B 17.12×2.62
- Ports X and Y 10×2.5

Size 20

- Ports A and B 24×3
- Ports X and Y 10×2.5

Size 32

- Ports A and B 34×3
- Ports X and Y 10×2.5

- 5 Valve with cracking pressure versions "1" and "2" (dimension L2)
- 6 Valve with opening pressure versions "3" and "4" (dimension L3)
- 7 6 valve mounting holes with type SV/SL 30

Valve fixing screws:

Internal hexagon screw

Size 10: 4-M10×50 GB/T 70.1-10.9
tightening torque $M_A=75$ Nm

Size 20: 4-M10×75 GB/T 70.1-10.9
tightening torque $M_A=75$ Nm

Size 30: 6-M10×85 GB/T 70.1-10.9
tightening torque $M_A=75$ Nm

it must be ordered separately, if connection plate is needed.

Type :

Size10:

- G460/01(G3/8), G460/02(M18×1.5)
- G461/01(G1/2), G461/02(M22×1.5)

Size20:

- G412/01(G3/4), G412/02(M27×2)
- G413/01(G1), G413/02(M33×2)

Size30:

- G414/01(G1¼), G414/02(M42×2)
- G415/01(G1½), G415/02(M48×2)

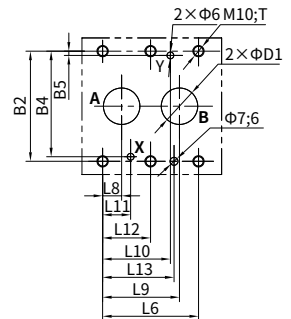

Type	size	L1	L2	L3	L4	L5	L6	L7	L8	L9	L10
SV	10	100.8	15.5	15.5	87.8	13	42.9	18.5	7.2	35.8	-
	20	135	17.7	47.7	117	18	60.3	27.5	11.1	49.2	-
	32	156.1	36.1	46.1	134	22.1	84.2	39	16.7	67.5	-
SL	10	100.8	15.5	15.5	87.8	13	42.9	18.5	7.2	35.8	21.5
	20	135	17.7	47.7	117	18	60.3	27.5	11.1	49.2	39.7
	32	156.1	36.1	46.1	134	22.1	84.2	39	16.7	67.5	59.5

Type	size	L11	L12	L13	B1	B2	B3	B4	B5	H1	H2	H3	D1	T
SV	10	21.5	-	31.8	84	66.7	46	58.8	-	51	29	36	13	23
	20	20.6	-	44.5	100	79.4	63.5	73	-	70	37	55	22	24
	32	24.6	42.1	62.7	118	96.8	75	92.8	-	85	42.5	69	32	25
SL	10	21.5	-	31.8	84	66.7	46	58.8	7.9	51	29	36	13	23
	20	20.6	-	44.5	100	79.4	63.5	73	6.4	70	37	55	22	24
	32	24.6	42.1	62.7	118	96.8	75	92.8	3.8	85	42.5	69	30	25

Unit dimensions

(Dimensions in mm)

• threaded connection valve

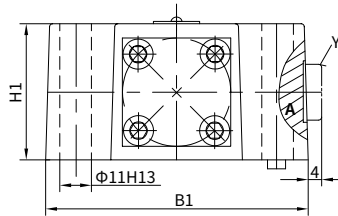
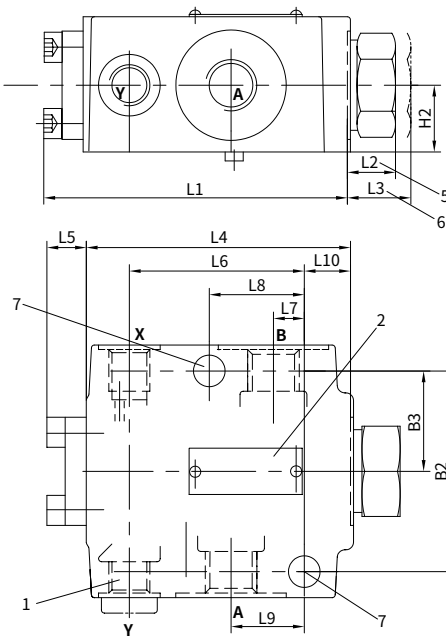

- 1 Port Y with valve type "SL" (with valve type "SV" this port is closed)
- 2 Name plate
- 5 Valve with cracking pressure versions "1" and "2" (dimension L2)
- 6 Valve with cracking pressure versions "3" and "4" (dimension L3)
- 7 2 valve mounting holes

Caution:

On threaded connection valves, series L4X and series 30 have different connection dimensions. If series 30 valves need to be replaced by series L4X ones, the pitch of installation holes and the position of external tapping shall be changed. And as for the series 30 threaded connection valves, their configuration and connection dimensions see the Ordering code on next page.

Type	Size	Ports	
		A, B	X, Y
SV	10	G1/2 M22×1.5	G1/4 M14×1.5
	16	G3/4 M27×2	
	20	G1 M33×2	
	25	G11/4 M42×2	
SL	32	G11/2 M48×2	G1/4 M14×1.5
	10	G1/2 M22×1.5	
	16	G3/4 M27×2	
	20	G1 M33×2	
SL	25	G11/4 M42×2	G1/4 M14×1.5
	32	G11/2 M48×2	

Type	Size	L1	L2	L3	L4	L5	L6	L7	L8	L9	L10	B1	B2	B3	H1	H2
SV	10	100.8	15.5	15.5	87.8	13	56.5	10.5	33.5	22.5	17.3	87	66.7	33.4	44	22
	16;20	133	17.7	47.7	115	18	74.5	17	50.5	36	27	105	79.4	39.7	68	34
	25;32	156.1	35.7	45.7	134	22.1	101	24	84	49	18	130	96.8	48.4	86	43
SL	10	100.8	15.5	15.5	87.8	13	56.5	10.5	33.5	22.5	17.3	87	66.7	33.4	44	22
	16;20	133	17.7	47.7	115	18	74.5	17	50.5	36	27	105	79.4	39.7	68	34
	25;32	156.1	35.7	45.7	134	22.1	101	24	84	49	18	130	96.8	48.4	86	43

Unit dimensions

(Dimensions in mm)

• threaded connection valve

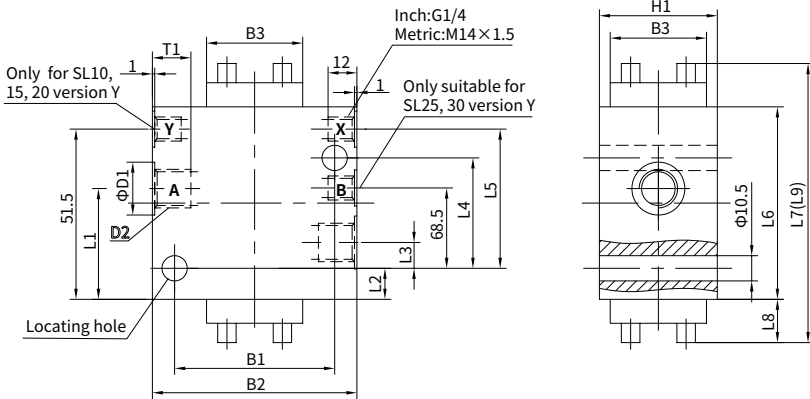

Type	Size	B1	B2	B3	D1	T1	H1	L1	L2	L3	L4	L5	L6	L7	L8	L9	Inch	Metric D2
SV	10	66.5	85	40	34	14	43	27.5	18.5	10.5	33.5	49	80	116	18	116	G1/2	M22×1.5
	15	79.5	100	55	42	16	57	36.5	17.5	13	50.5	67.5	95	135	20	146	G3/4	M27×2
	20	79.5	100	55	47	18	57	36.5	17.5	13	50.5	67.5	95	135	20	146	G1	M33×2
	25	97	120	70	56	20	75	54.5	15.5	20.5	73.5	89.5	115	173	29	179	G11/4	M42×2
	30	97	120	70	61	22	75	54.5	15.5	20.5	73.5	89.5	115	173	29	179	G11/2	M48×2
SL	10	66.5	85	40	34	14	43	22.5	18.5	10.5	33.5	49	80	116	18	116	G1/2	M22×1.5
	15	79.5	100	55	42	16	57	30.5	17.5	13	50.5	72.5	100	140	20	151	G3/4	M27×2
	20	79.5	100	55	47	18	57	30.5	17.5	13	50.5	72.5	100	140	20	151	G1	M33×2
	25	97	120	70	56	20	75	54.5	15.5	20.5	84	99.5	125	183	29	189	G11/4	M42×2
	30	97	120	70	61	22	75	54.5	15.5	20.5	84	99.5	125	183	29	189	G11/2	M48×2

Note: Dimension L7 suits valve with opening pressure types "1" and "2", and dimension L9 suits valve with opening pressure types "3".

Ordering code: for threaded connection valve type SV/SL series30

S		V		30		*
No leakage port	= V					Further details in clear text
With leakage port	= L					
Nominal size10	= 10					No code = NBR seals
Nominal size15	= 15					V = FKM seals
Nominal size 20	= 20					No code = Inch
Nominal size25	= 25					2 = Metric
Nominal size30	= 30					30 = Series 30
Threaded connection	= G					
With pre-opening(standard version)	= A					1 = Opening pressure 3 bar
No pre-opening	= B					2 = Opening pressure 5 bar
						3 = Opening pressure 8 bar

